

LISTA CZĘŚCI / PARTS LIST / SEZNAM DÍLŮ

Nr. części (Part no.)	Ilość (Quantity)	Kod	Nazwa części (Part name)	Opis (Details)	Part name
1	1		Rama	MS-L101	Frame
2	1		Profil akcesoriów	MS-L101	Profile of accessories
3	1		Siedzisko	MS-L101	Seat
6	22	1000320	Podkładka	D10	Washer
7	4	1001792	Nakrętka samokontrująca	M10	Self-Locking Nut
8	8	1001793	Nakrętka	M10	Nut
9	4	1001795	Zaślepka gumowa	50x30	Endcap
10	1	1001844	Przelotka	50x50	Reducer cap
11	2	1001859	Śruba	HEX M10x135	HEX Bolt
12	4	1001861	Śruba podsadzana	SPH M10x45	Carriage bolt
13	6	1001864	Śruba	HEX M10x70	HEX Bolt
14	2	1001902	Tulejka	D16x1,5x20	Bushing
15	21	1001994	Nakładka na śrubę	M10	Endcap
16	1	1002005	Uchwyt	D45x32xM10	Handle
17	1	1002007	Stelaż oparcia L-300	Stelaż oparcia L-300	
18	1	1002038	Pokrętło dociskowe	D62xM12x28	Hand knob
19	1	1002039	Zaślepka	40x40	Endcap
20	6	1002040	Zaślepka	20x40	Endcap
21	10	1003441	Wkręt hart. 4x20 Zn	D4x20	Screw
22	1	1003659	Śruba	HEX M10x80	HEX Bolt
23	2	1004177	Tulejka	D16x1,5x13	Bushing
24	1	1006141	Noga gięta	50x30x2x600	Profile
25	2	2100388	Błacha	3x146x655	Plate
26	1	2120066	Profil	40x40x1,5x410-2	Profile
27	1	1001967	Noga standardowa L=388	L=388	Profile
28	1	2200004	Przetyczka	D8x160	Lock pin
29	1	2200009	Przetyczka	D10	Lock pin
30	1	2300024	Naklejka Marbo-Sport	32x46	Sticker MARBO-SPORT
39	1	155	Tapicerka	50x270x300	Upholstery
40	1	145	Tapicerka	50x270x810	Upholstery

INSTRUKCJA MONTAŻU

ASSEMBLY INSTRUCTION

NÁVODK MONTÁŽI

Ławka dwustronna

MS-L101

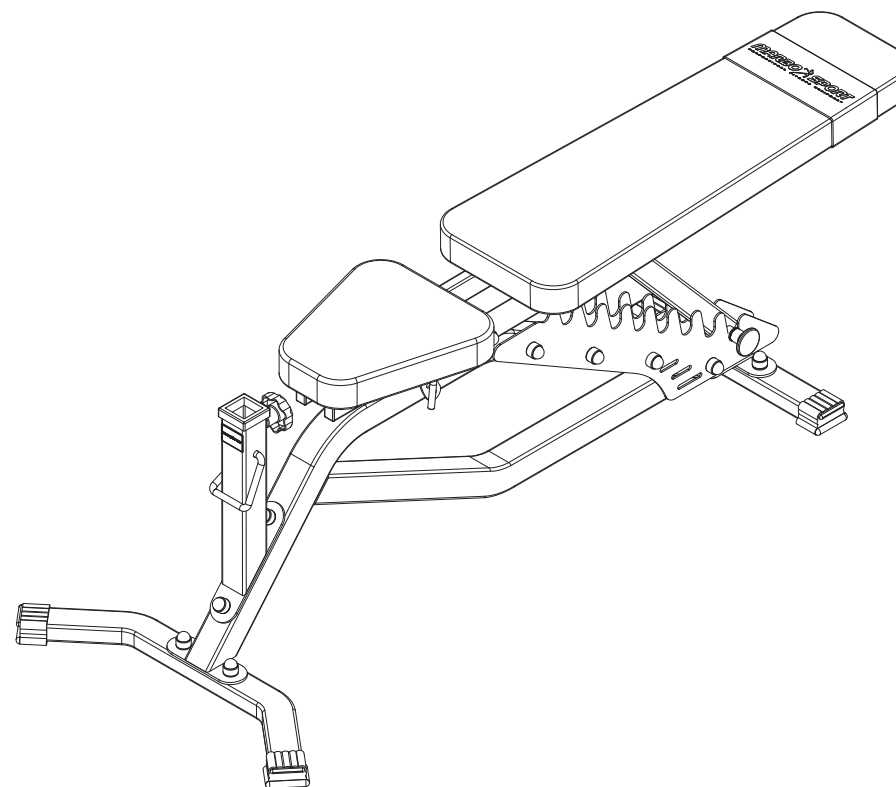

MARBO SPORT
PROFESSIONAL FITNESS EQUIPMENT
www.marbo-sport.pl

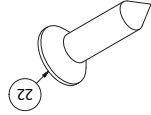
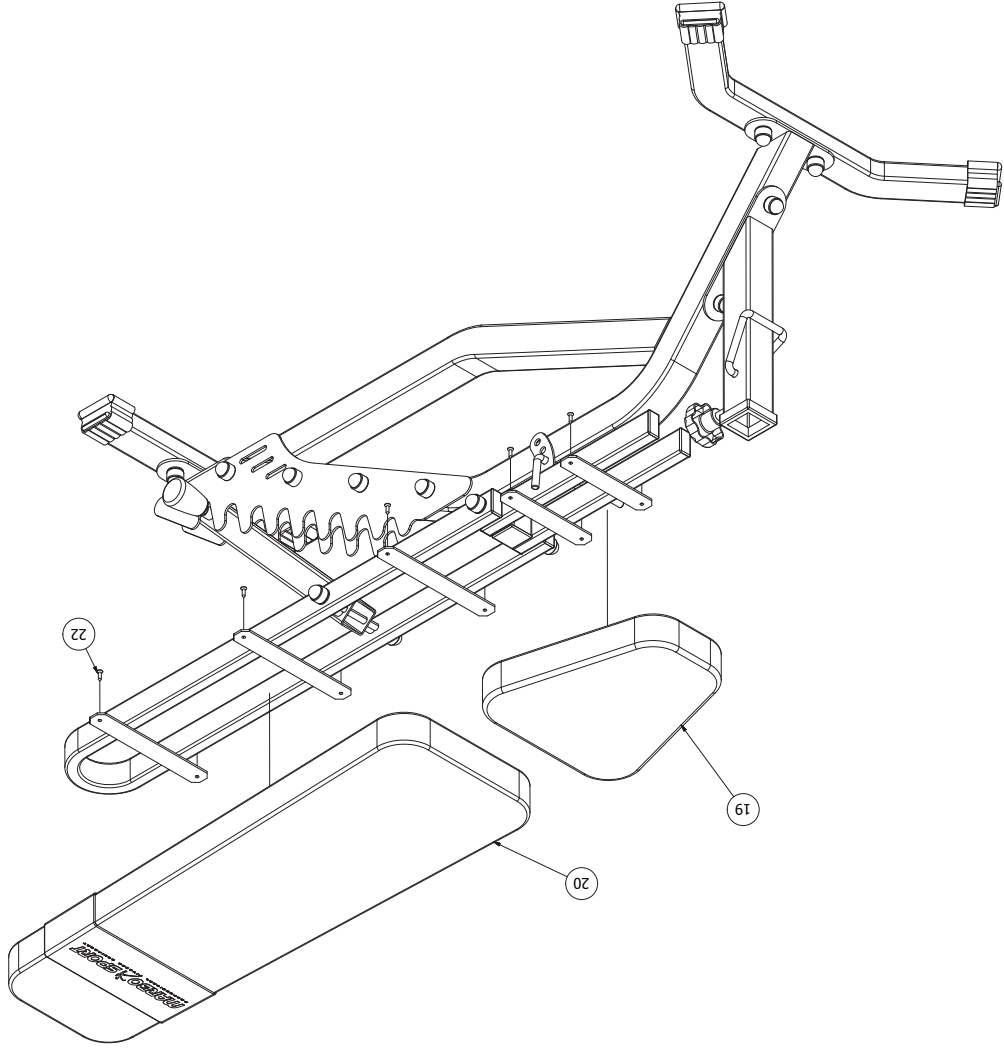
KROK 5 / STEP 5 / KROK 5

Wkręt
Ø4x20
X10

PRZED MONTAŻEM

- ▶ Przeczytaj to zanim rozpoczniesz montaż urządzenia
- ▶ Podczas montażu, podążaj zgodnie z instrukcją
- ▶ Montaż rozpocznij od pierwszego kroku kończąc na ostatnim.
- ▶ Instrukcja montażu podzielona jest na etapy (kroki), wykonuj jeden etap na raz.
- ▶ Dopiero po jego ukończeniu, przejdź do następnego kroku.
- ▶ Jeśli podczas montażu zorientujesz się, że brakuje którejś części, poinformuj nas o tym podając jej numer.
- ▶ Aby ułatwić montaż, zastosowaliśmy w instrukcji linie montażowe.
- ▶ Urządzenie musi być sprawdzone co najmniej raz w tygodniu pod względem pozycji dokręcenia śrub, nakrętek i elementów tapicerowanych
- ▶ które mogą się luzować podczas użytkowania urządzenia, a także pod względem zużycia elementów obrotowych

PRZED MONTAŻI

- ▶ This must be read before you start assembling this unit.
- ▶ You must follow the assembly instructions exactly as outlined.
- ▶ Assemble this unit starting at the beginning and work to the end
- ▶ The assembly instructions are set out so that you are only doing one section at a time,
- ▶ therefore you will finish one section and move on to the next.
- ▶ If something is missing when assembling this unit, you must notify us of the part number of the exact nut, bolt or part that is missing.
- ▶ To help you assemble this unit we have used line drawings.
- ▶ Check the line drawings for the exact positioning of the parts.
- ▶ The unit will need to be checked at least once a week for nuts and bolts that can work loose, uphoistered pieces working loose and wear on pivot assemblies.

POTRZEBNE NARZĘDZIA / TOOLS NEEDED / POTŘEBNÁ NÁŘADÍ

KLUCZ OCZKOWY
KŁIČ S OČKEM
2X17



MR.OTEK GUMOWY
GUMOWE KŁADIVO



ŠRUBOKRĚT
SCREWDRIVER
2X17

KROK 4 / STEP 4 / KROK 4

Nakrętka
(Nut)
M10
x1

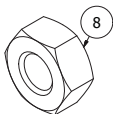

Podkładka
(Washer)
M10
x2

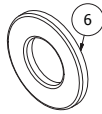

Przetyczka
(Lock pin)
D10
x1

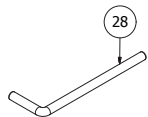

Nakł. na śr.
(End cap)
M10
x2

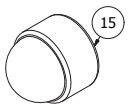

Zaślepka
(End cap)
20x40
x6

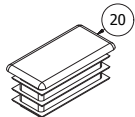

Śruba
(Hex bolt)
M10x135
x1

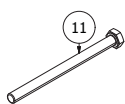

Naklejka
(Sticker)
32x46
x1

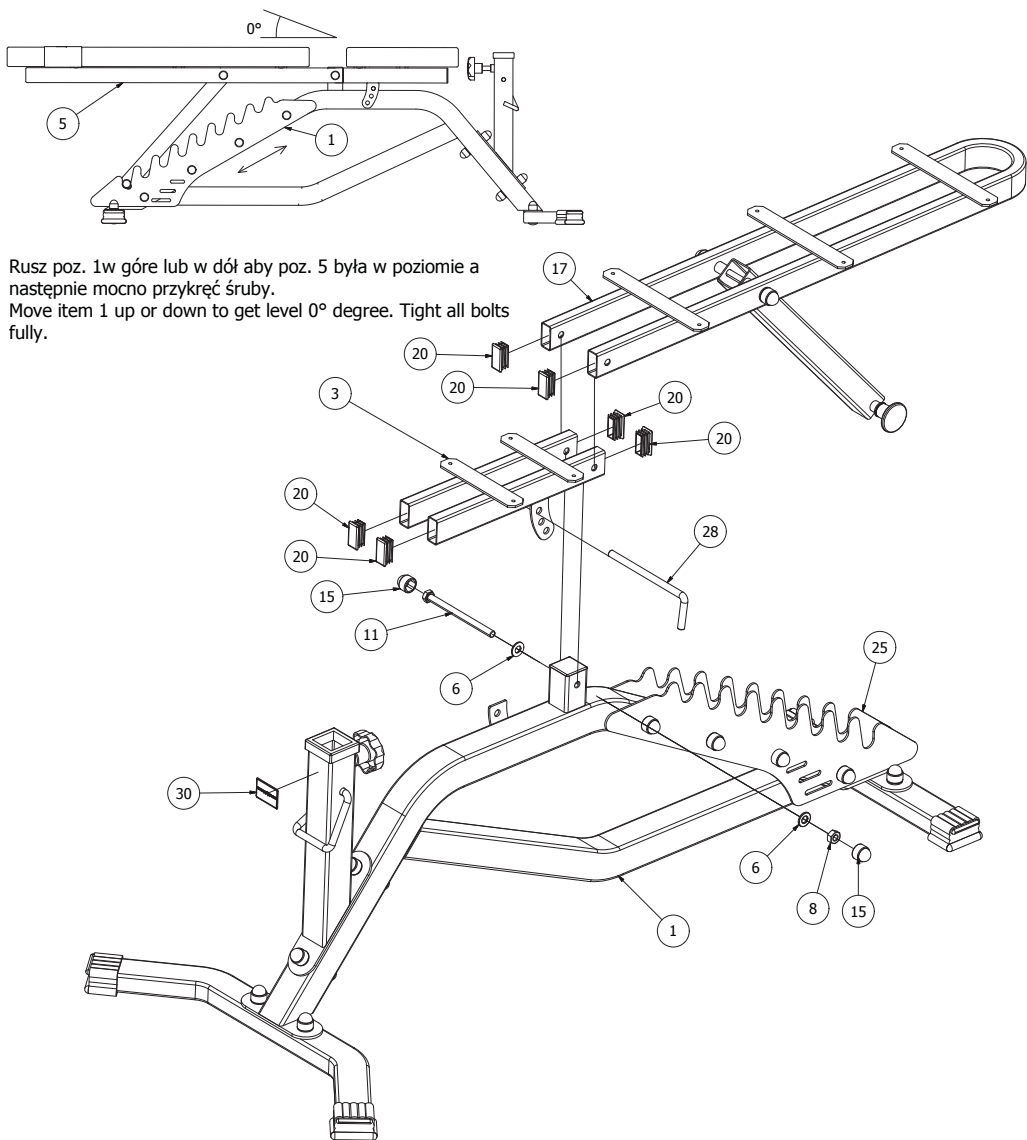

Rusz poz. 1w górę lub w dół aby poz. 5 była w poziomie a następnie mocno przykręć śruby.
Move item 1 up or down to get level 0° degree. Tight all bolts fully.

KROK 1 / STEP 1 / KROK 1

Zaślepka gumowa
(End cap)
50x30
x4



Nakrętka
(Nut)
M10
x4

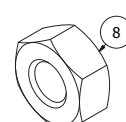

Śruba podsadzana
(Carriage bolt)
M10x45
x4

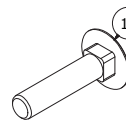

Podkładka
(Washer)
M10
x4

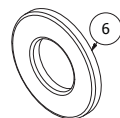

Zaślepka
(End cap)
40x40
x1

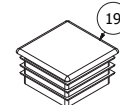

Nakł. na śr.
(End cap)
Ø10
x4

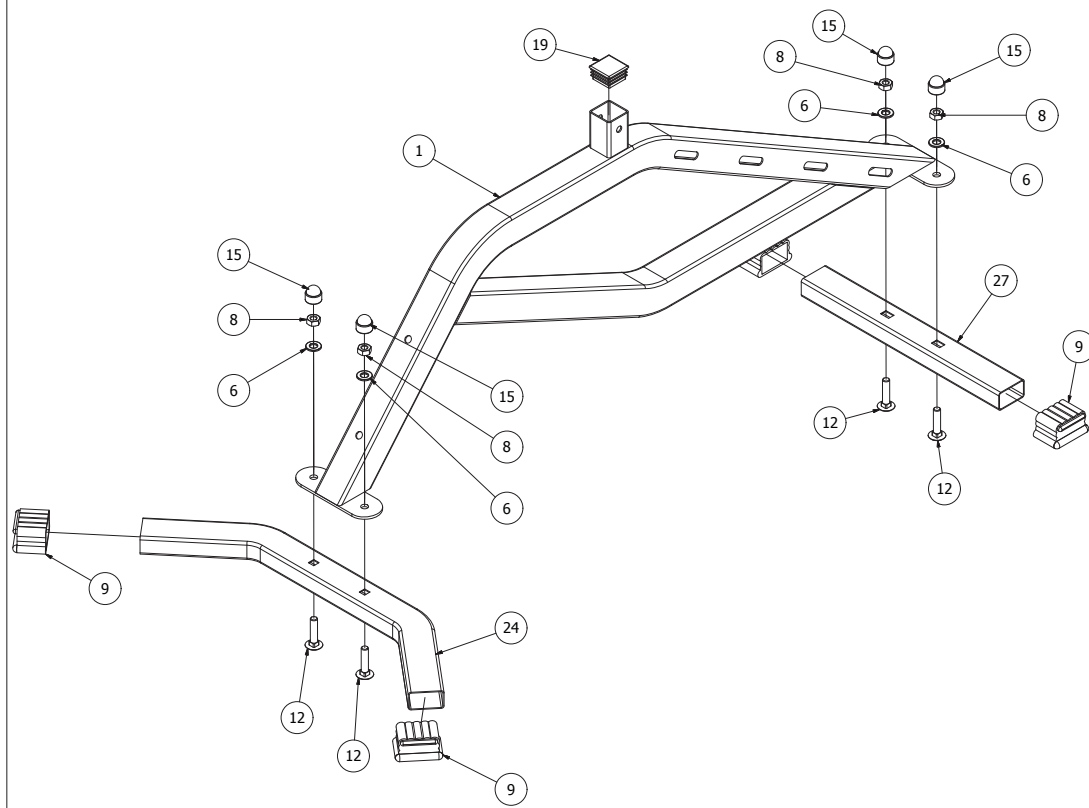
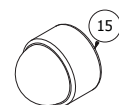

KROK 2 / STEP 2 / KROK 2

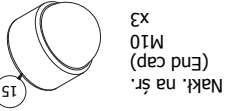
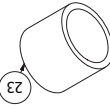
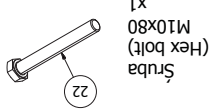
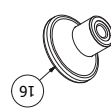
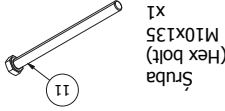
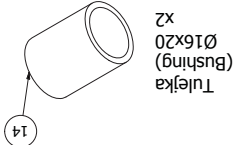
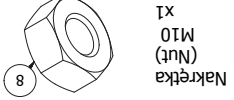
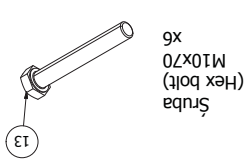
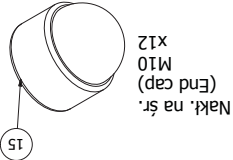
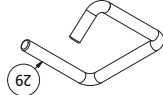
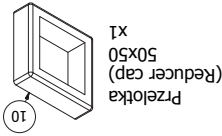
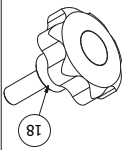
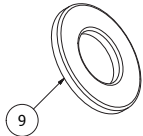
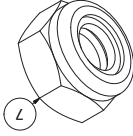
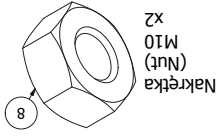
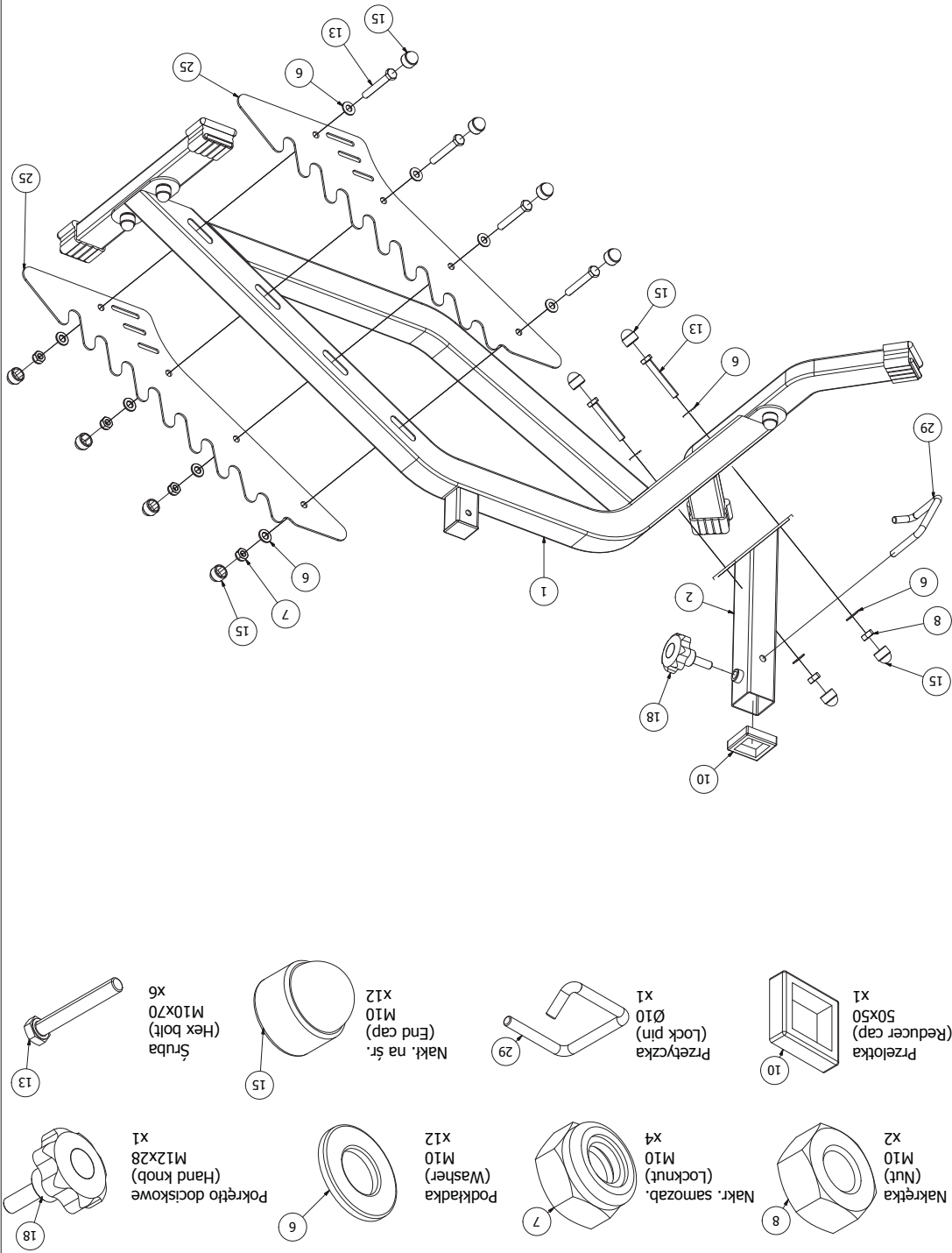

KROK 3 / STEP 3 / KROK 3

